

2024  
商業照明  
型錄

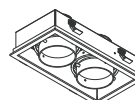

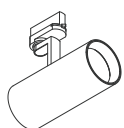

Ledionopto

雷笛揚智能

# Leidi on pto

# 目錄

## CONTENTS

### ▪ 羅盤系列-嵌燈 Pyxis Series

PYX-A 嵌入式搖擺嵌燈	P01-P02
PYX-B 嵌入式搖擺嵌燈	P03-P04
PYX-C 嵌入式搖擺嵌燈	P05-P06
PYX-D 嵌入MR16模組嵌燈	P07-P08
PYX-D 嵌入MR16模組嵌燈	P09-P10
PYX-E 嵌入式固定嵌燈	P11-P12
PYX-F 嵌入式搖擺嵌燈	P13-P14
PYX-G 嵌入式搖擺嵌燈	P15-P16
PYX-H 嵌入式搖擺嵌燈	P17-P18
PYX-I 嵌入式象鼻燈	P19-P20
PYX-K IP65嵌入式嵌燈	P21-P22
PYX-L 嵌入下拉嵌燈	P23-P24
PYX-M 嵌入式長條嵌燈	P25-P26
PYX-N 嵌入式窄角嵌燈	P27-P28
PYX-O 嵌入式窄角嵌燈	P29-P28
PYX-P PLCC LITE III	P31-P32

### ▪ 帆船系列-吸頂燈 Vela Series

VEL-A 櫥櫃燈	P45-P46
VEL-B IP44吸頂燈	P47-P48
VEL-C 吸頂燈	P49-P50
VEL-CT 軌道燈	P51-P52
VEL-D 吸頂燈	P53-P54

### ▪ 望遠鏡系列-軌道燈 Telescopium Series

TEL-A 方形軌道燈	P33-P34
TEL-B 軌道燈	P35-P36
TEL-C 軌道燈	P37-P38
TEL-E 軌道燈	P39-P40

### ▪ 圓規系列-吊燈 Circinus Series

CIR-A 吊燈	P55-P56
CIR-B 吊燈	P57-P58
CIR-C 調焦吊燈	P59-P60
CIR-CT 調焦軌道燈	P61-P62

### ▪ 時鐘系列-盒燈 Horologium Series

HOP-A盒燈	P41-P42
HOP-B盒燈	P43-P44

### ▪ 配件系列-配件 Accessories Series

ACC 軌道	P63-P64
--------	---------



# Pyxis Series

## PYX-A 嵌入式搖擺崁燈

面框: ○ 白 ● 黑



55

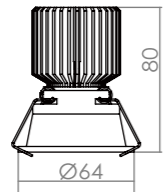

75

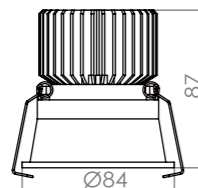

95

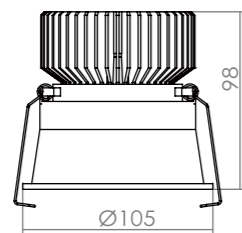

單位:mm

- 可變發光方向
- 低眩光
- 高演色性真實還原色彩

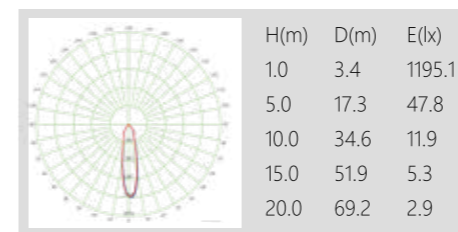

E23DR-903008002

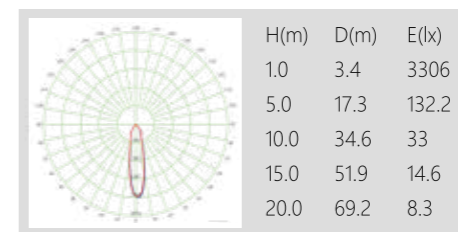

E23DR-903015001

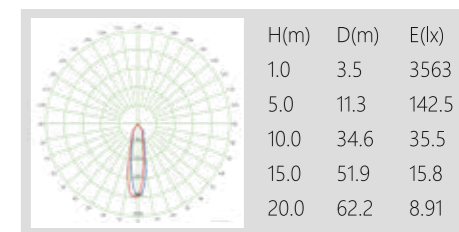

E23DR-903020008

型號	功率 (W)	電壓 (V)	色溫 (K)	色容差	光通量	顯色指數 (Ra)	光束角	燈具尺寸 (mm)	挖孔尺寸 (mm)
E23DR-903008002	8W	100V-277V	3000K	3 SDCM	680lm	≥90	25°/45°	H80×Φ64mm	Φ55mm
E23DR-903015001	15W	100V-277V	3000K	3 SDCM	1100lm	≥90	25°/45°	H87×Φ84mm	Φ75mm
E23DR-903020008	20W	100V-277V	3000K	3 SDCM	1700lm	≥90	25°/45°	H98×Φ105mm	Φ95mm



# Pyxis Series

## PYX-B 嵌入式搖擺嵌燈



75

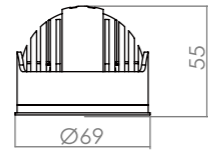

55

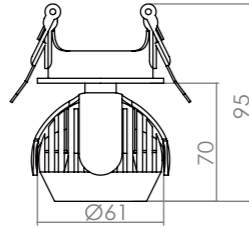

75

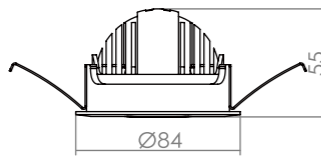

單位:mm

- 可變發光方向
- 低眩光
- 高演色性真實還原色彩



面框: ○ 白 ● 黑

遮光罩: ○ 白 ● 黑 ● 電鍍銀

無邊預埋框款:

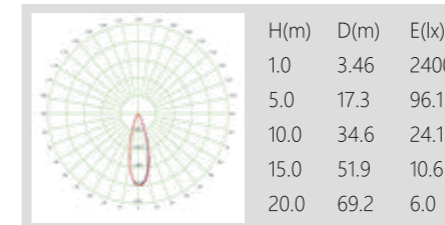

E23DR-903010002

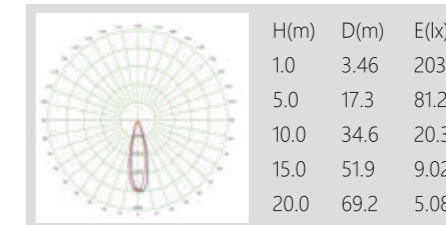

E23DR-903010003

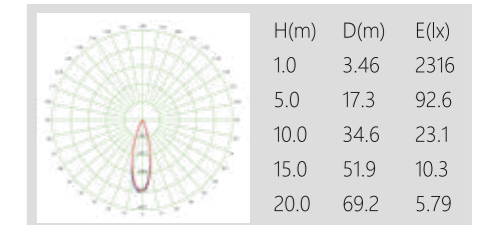

E23DR-903010004

型號	功率 (W)	電壓 (V)	色溫 (K)	色容差	光通量	顯色指數 (Ra)	光束角	燈具尺寸 (mm)	挖孔尺寸 (mm)
E23DR-903010002	10W	100V-277V	3000K	3 SDCM	725lm	≥90	24°/38°	H55×Φ69mm	Φ75mm
E23DR-903010003	10W	100V-277V	3000K	3 SDCM	435lm	≥90	24°/38°	H95×Φ61mm	Φ55mm
E23DR-903010004	10W	100V-277V	3000K	3 SDCM	625lm	≥90	24°/38°	H55×Φ84mm	Φ75mm







PYX-C Series





# Pyxis Series

## PYX-C 嵌入式搖擺嵌燈



55

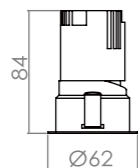

75

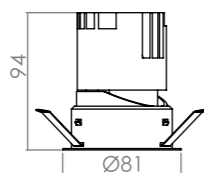

95

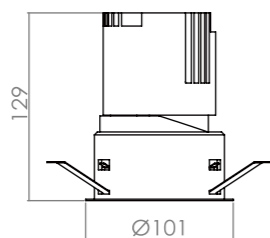

120

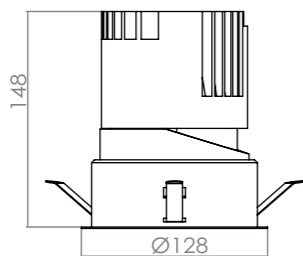

單位:mm

■ 可變發光方向

■ 低眩光

■ 高演色性真實還原色彩



面框: ○ 白

遮光罩: ● 電鍍銀

無邊預埋框款:



可選面蓋:

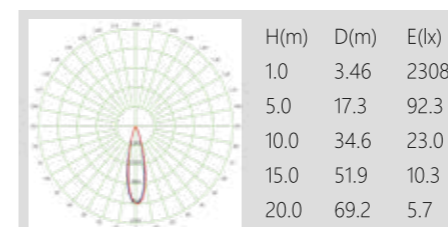

E23DR-903007006

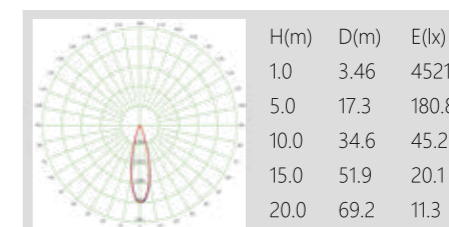

E23DR-903012001

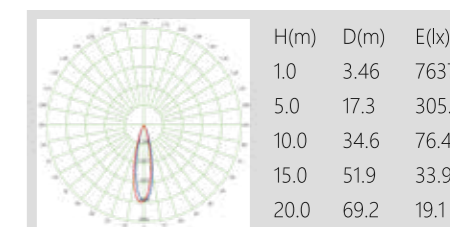

E23DR-903020007

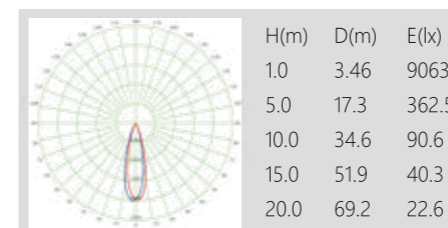

E23DR-903026001

型號	功率 (W)	電壓 (V)	色溫 (K)	色容差	光通量	顯色指數 (Ra)	光束角	燈具尺寸 (mm)	挖孔尺寸 (mm)
E23DR-903007006	7W	100V-277V	3000K	3 SDCM	460lm	≥90	24°/36°	H84×Φ62mm	Φ55mm
E23DR-903012001	12W	100V-277V	3000K	3 SDCM	1035lm	≥90	24°/36°	H94×Φ81mm	Φ75mm
E23DR-903020007	20W	100V-277V	3000K	3 SDCM	1630lm	≥90	24°/36°	H129×Φ101mm	Φ95mm
E23DR-903026001	26W	100V-277V	3000K	3 SDCM	2170lm	≥90	24°/36°	H148×Φ128mm	Φ120mm



# Pyxis Series

## PYX-D 嵌入MR16模組嵌燈

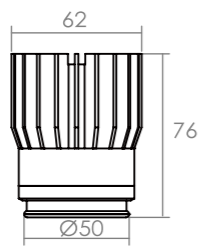
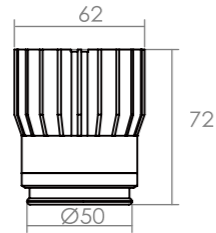
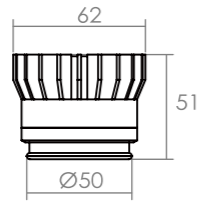

單位:mm

■ 可變發光方向

■ 低眩光

■ 高演色性真實還原色彩



面框: ○ 白

遮光罩: ● 電鍍黑 ● 電鍍黑 ● 黑

無邊預埋框款:



有框款:

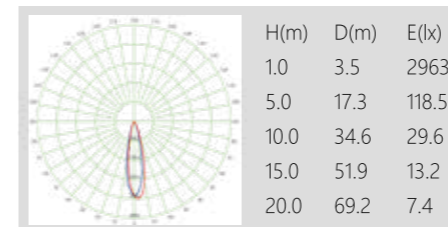

E23DR-903009006

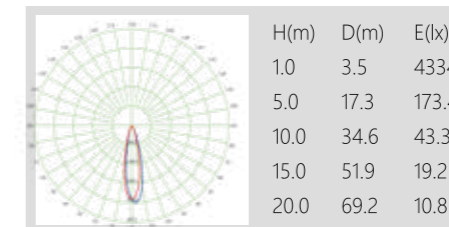

E23DR-903012006

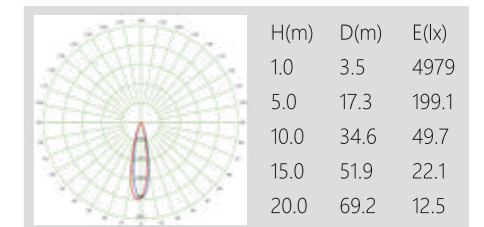

E23DR-903015006

型號	功率 (W)	電壓 (V)	色溫 (K)	色容差	光通量	顯色指數 (Ra)	光束角	燈具尺寸 (mm)	挖孔尺寸 (mm)
E23DR-903009006	9W	100V-277V	3000K	3 SDCM	785lm	≥90	25°	H51×Φ50mm	
E23DR-903012006	12W	100V-277V	3000K	3 SDCM	1145lm	≥90	25°	H72×Φ50mm	
E23DR-903015006	15W	100V-277V	3000K	3 SDCM	1300lm	≥90	25°	H76×Φ50mm	



# Pyxis Series

## PYX-D 嵌入MR16模組面框



E23FE-010202001



E23FE-010202002

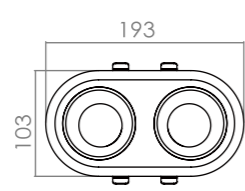
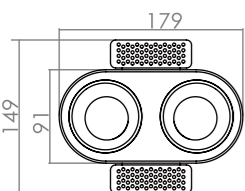

E23FR-010101001



E23FR-010201003

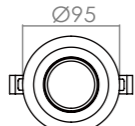
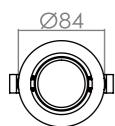

E23FR-010101002



E23FR-010501001

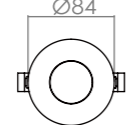
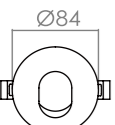

E23FR-010201001



E23FR-010201002

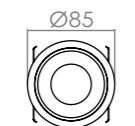
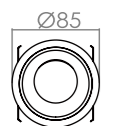

面框: ○ 白

遮光罩: ● 電鍍黑 ● 電鍍黑 ● 黑

無邊預埋框款: 

有框款: 

型號	面框尺寸 (mm)	挖孔尺寸 (mm)
E23FE-010202001	H63×91×179mm	93X183mm
E23FR-010101001	H34×Φ84mm	Φ75mm
E23FR-010501001	H41×Φ84mm	Φ75mm
E23FR-010101002	H41×Φ84mm	Φ75mm
E23FE-010202002	H63×103×193mm	90X188mm
E23FR-010201001	H59×Φ85mm	Φ75mm
E23FR-010201002	H59×Φ85mm	Φ75mm
E23FR-010201003	H37×Φ95mm	Φ75mm



單位:mm



# Pyxis Series

## PYX-E 嵌入式固定嵌燈

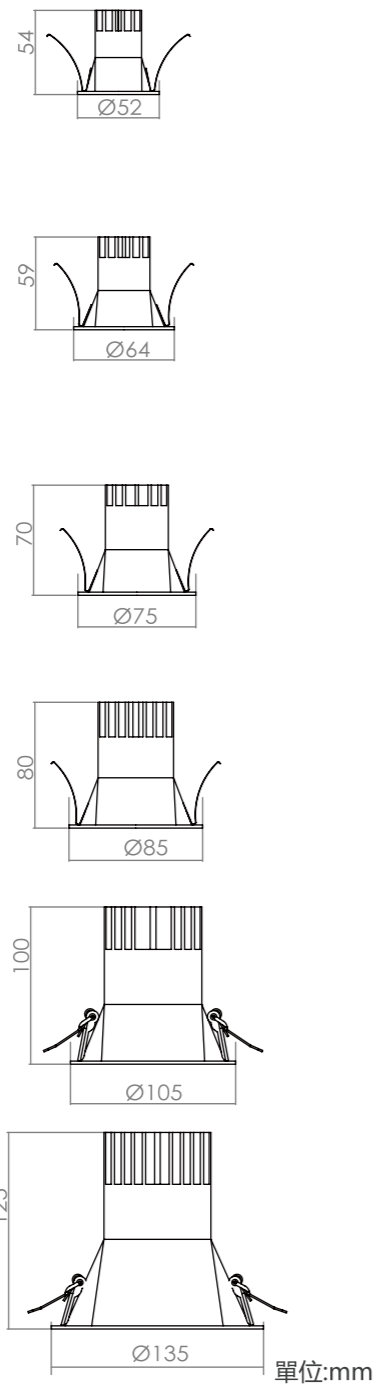

- 可變發光方向
- 低眩光
- 高演色性真實還原色彩



面框: ○ 白

遮光罩: ● 電鍍銀

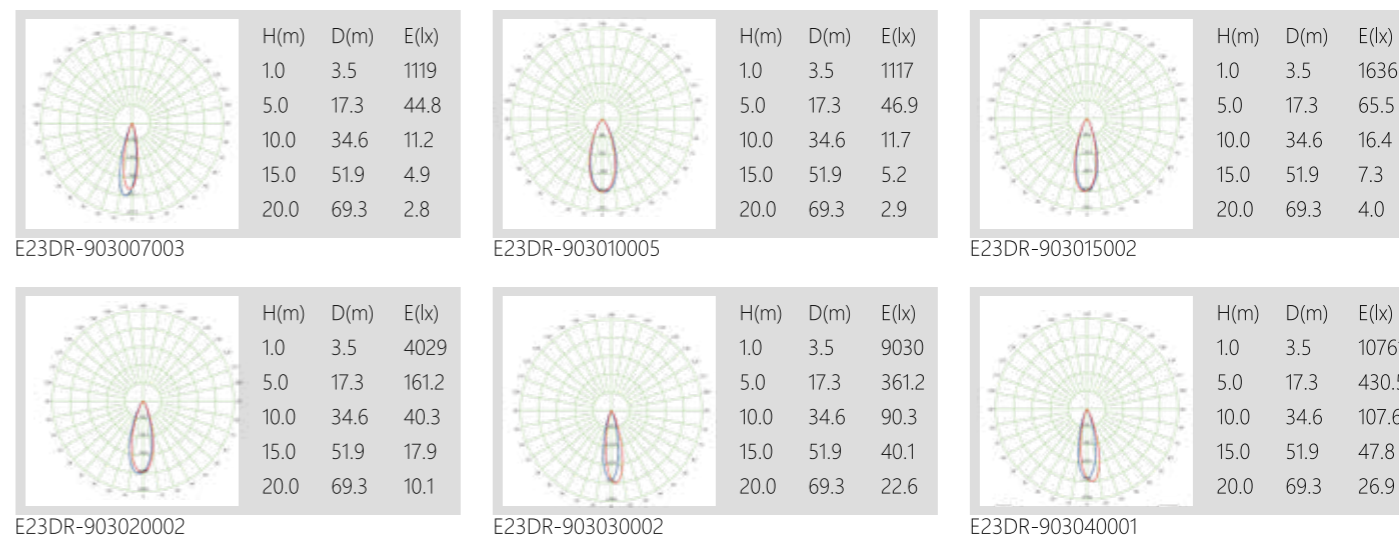

型號	功率 (W)	電壓 (V)	色溫 (K)	色容差	光通量	顯色指數 (Ra)	光束角	燈具尺寸 (mm)	挖孔尺寸 (mm)
E23DR-903007003	7W	100V-277V	3000K	3 SDCM	280lm	≥90	24°/38°	H80×Φ52mm	Φ45mm
E23DR-903010005	10W	100V-277V	3000K	3 SDCM	630lm	≥90	24°/38°	H80×Φ64mm	Φ55mm
E23DR-903015002	15W	100V-277V	3000K	3 SDCM	620lm	≥90	24°/38°	H101×Φ75mm	Φ65mm
E23DR-903020002	20W	100V-277V	3000K	3 SDCM	1580lm	≥90	24°/38°	H101×Φ85mm	Φ75mm
E23DR-903030002	30W	100V-277V	3000K	3 SDCM	2205lm	≥90	24°/38°	H133×Φ105mm	Φ90mm
E23DR-903040001	40W	100V-277V	3000K	3 SDCM	3005lm	≥90	24°/38°	H133×Φ135mm	Φ120mm



# Pyxis Series

## PYX-F 嵌入式搖擺崁燈



55W

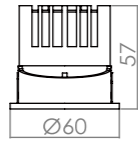

75W

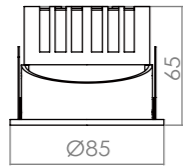

95W

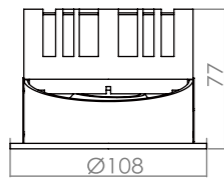

單位:mm

■ 可變發光方向

■ 低眩光

■ 高演色性真實還原色彩



面框: ○ 白 ● 黑

遮光罩: ● 電鍍銀

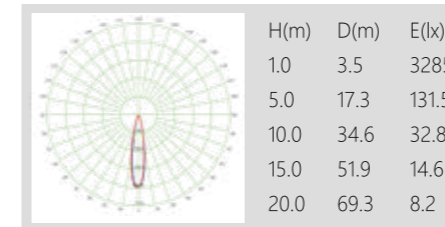

E23DR-903007004

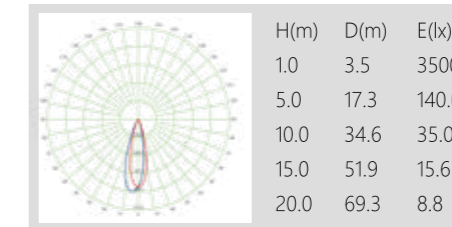

E23DR-903013001

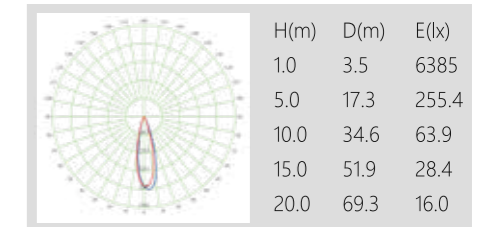

E23DR-903020003

型號	功率 (W)	電壓 (V)	色溫 (K)	色容差	光通量	顯色指數 (Ra)	光束角	燈具尺寸 (mm)	挖孔尺寸 (mm)
E23DR-903007004	8W	100V-277V	3000K	3 SDCM	535lm	≥90	15°/24°/36°	H57×Φ60mm	Φ55mm
E23DR-903013001	13W	100V-277V	3000K	3 SDCM	920lm	≥90	15°/24°/36°	H65×Φ85mm	Φ75mm
E23DR-903020003	20W	100V-277V	3000K	3 SDCM	1570lm	≥90	15°/24°/36°	H77×Φ108mm	Φ95mm





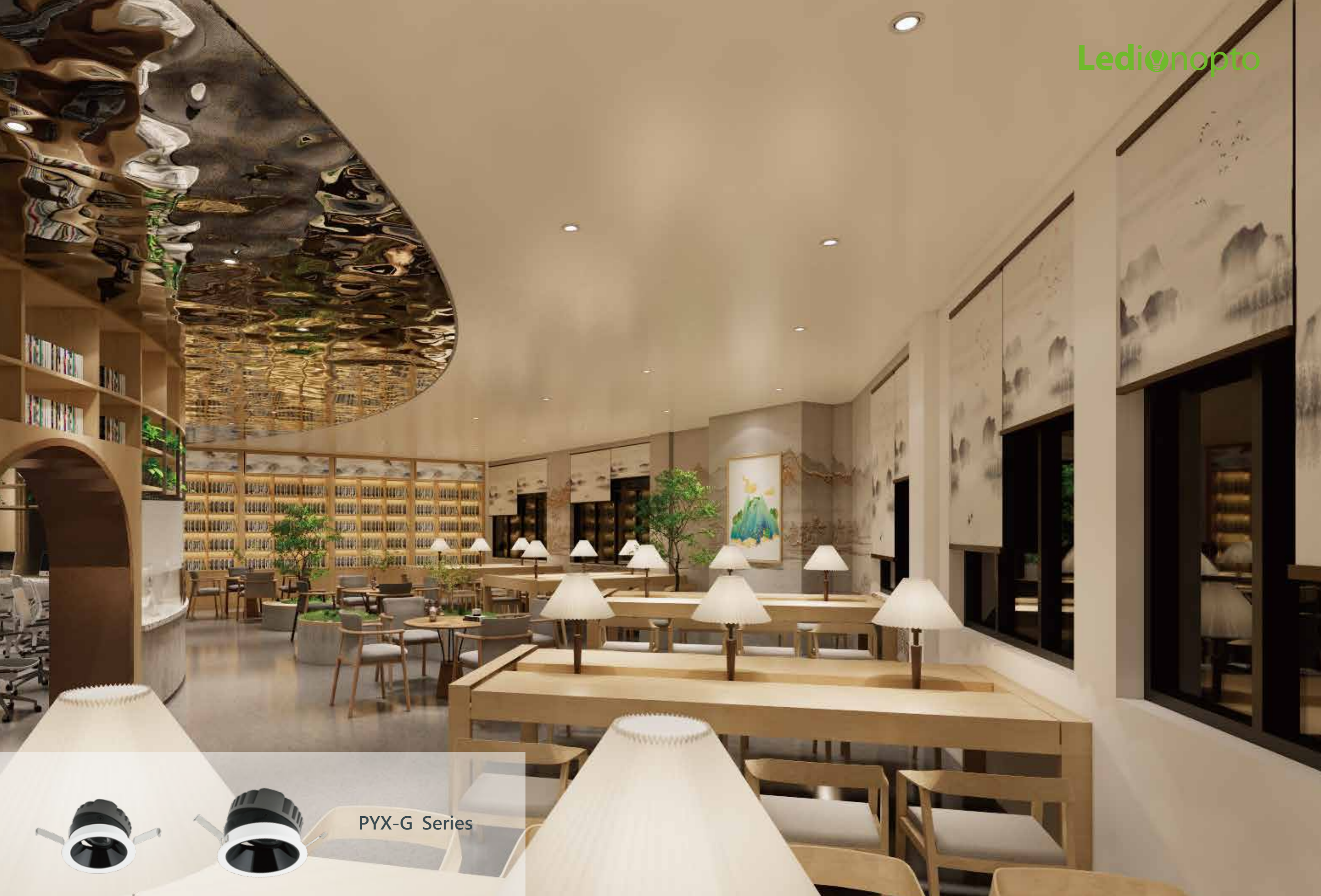

PYX-G Series



# Pyxis Series | PYX-G 嵌入式搖擺崁燈

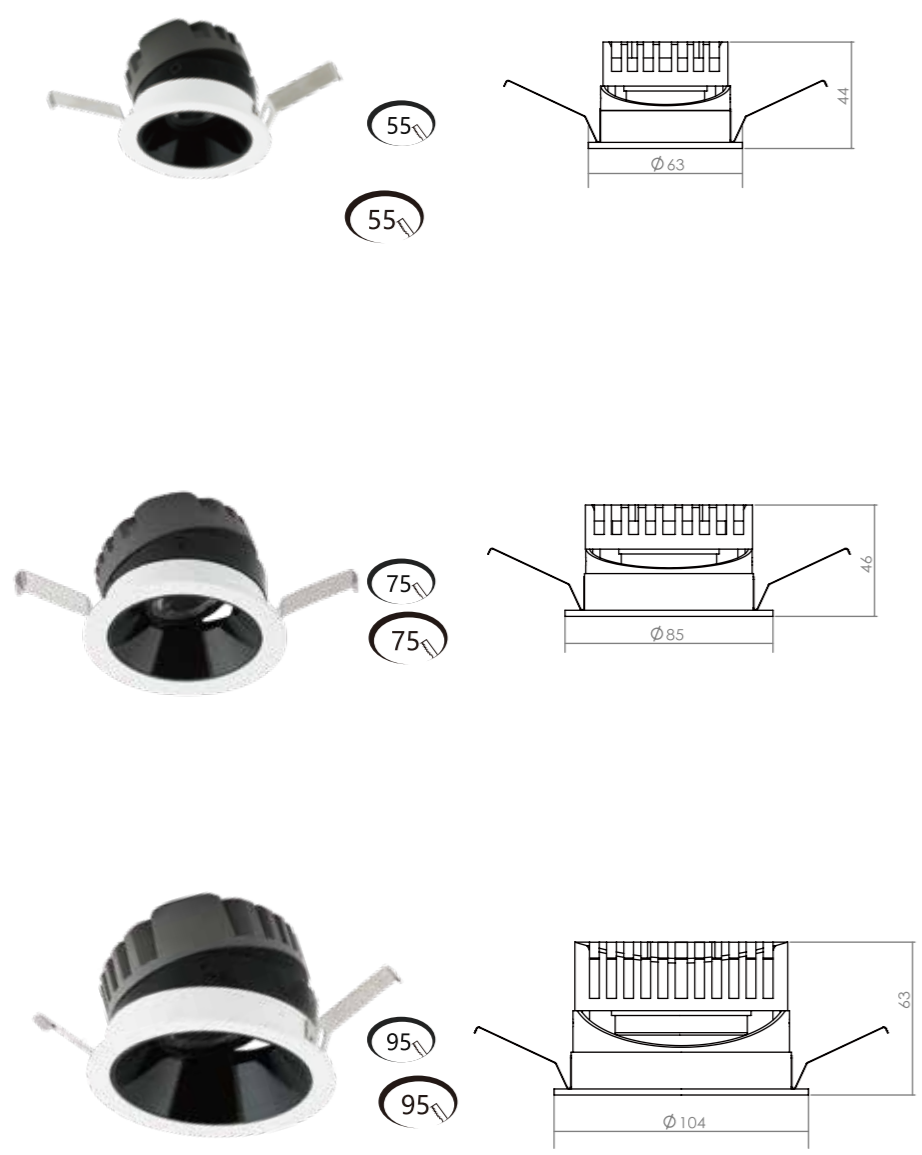

單位:mm

- 可變發光方向
- 低眩光
- 高演色性真實還原色彩



面框: ○ 白 ● 黑

遮光罩: ● 電鍍黑 ○ 白 ● 黑

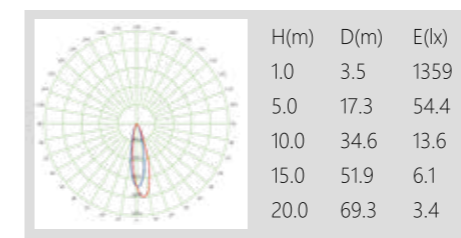

E23DR-903007005

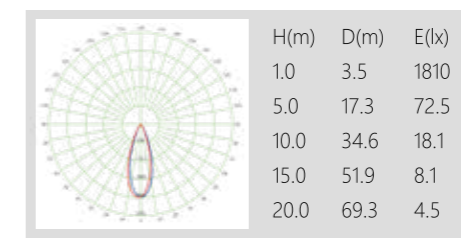

E23DR-903008003

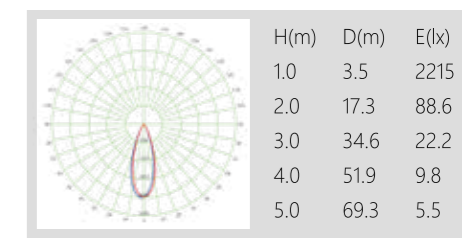

E23DR-903010006

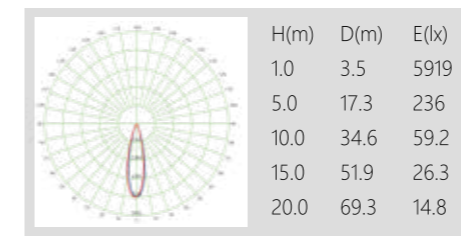

E23DR-903015003

型號	功率 (W)	電壓 (V)	色溫 (K)	色容差	光通量	顯色指數 (Ra)	光束角	燈具尺寸 (mm)	挖孔尺寸 (mm)
E23DR-903007005	7W	100V-277V	3000K	3 SDCM	380lm	≥90	8°/15°/24°	H44×Φ63mm	Φ55mm
E23DR-903008003	8W	100V-277V	3000K	3 SDCM	670lm	≥90	8°/15°/24°	H46×Φ85mm	Φ75mm
E23DR-903010006	10W	100V-277V	3000K	3 SDCM	850lm	≥90	8°/15°/24°	H63×Φ104mm	Φ75mm
E23DR-903015003	15W	100V-277V	3000K	3 SDCM	1750lm	≥90	8°/15°/24°	H63×Φ104mm	Φ95mm



# Pyxis Series

## PYX-H 嵌入式搖擺嵌燈

面框: ○ 白 ● 黑



75°

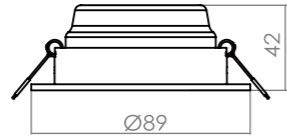

95°

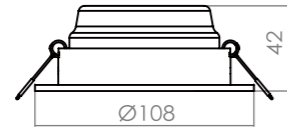

83°

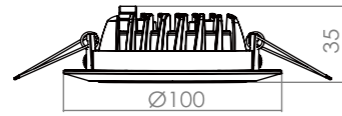

單位:mm

■ 可變發光方向

■ 低眩光

■ 高演色性真實還原色彩

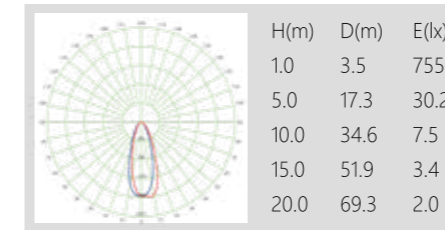

E23DR-903007001

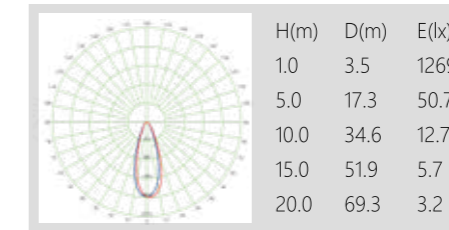

E23DR-903009001

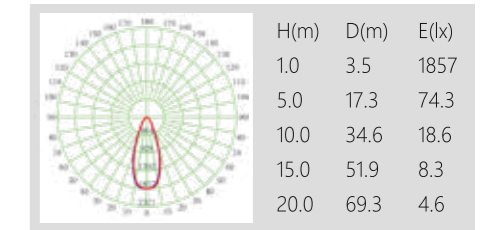

GT2DR-93DW3W1

型號	功率 (W)	電壓 (V)	色溫 (K)	色容差	光通量	顯色指數 (Ra)	光束角	燈具尺寸 (mm)	挖孔尺寸 (mm)
E23DR-903007001	7W	100V-277V	3000K	3 SDCM	490lm	≥90	24°/36°	H42×Φ89mm	Φ75mm
E23DR-903009001	9W	100V-277V	3000K	3 SDCM	710lm	≥90	24°/36°	H42×Φ108mm	Φ95mm
GT2DR-93DW3W1	9W	100V-277V	3000K	3 SDCM	1154lm	≥90	40°	H35×Φ100mm	Φ83mm



# Pyxis Series

## PYX-I 嵌入式象鼻燈



95

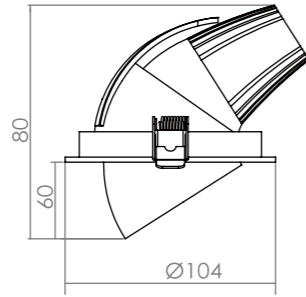

125

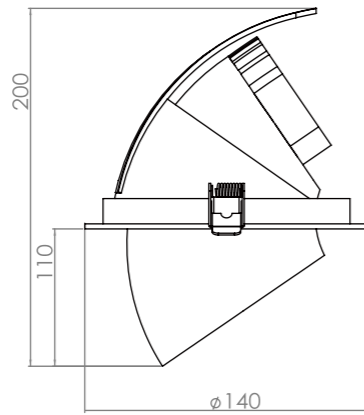

單位:mm

■ 象鼻頭可拉伸、360°旋轉

■ 低眩光、無頻閃

■ 高演色性真實還原色彩



面框: ○ 白 ● 黑

遮光罩: ● 黑

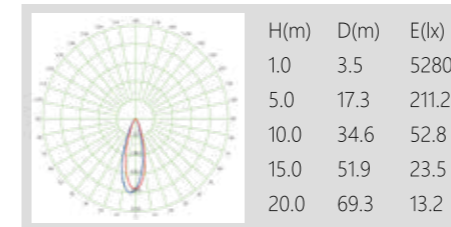

E23DR-903020006

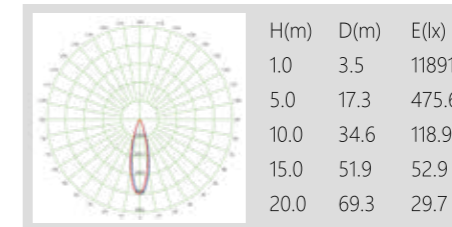

E23DR-903038001

型號	功率 (W)	電壓 (V)	色溫 (K)	色容差	光通量	顯色指數 (Ra)	光束角	燈具尺寸 (mm)	挖孔尺寸 (mm)
E23DR-903020006	20W	100V-277V	3000K	3 SDCM	1875lm	≥90	15°/24°/38°	H80×Φ104mm	Φ95mm
E23DR-903038001	38W	100V-277V	3000K	3 SDCM	2965lm	≥90	15°/24°/38°	H200×Φ140mm	Φ125mm





# Pyxis Series

## PYX-K IP65 嵌入式崁燈

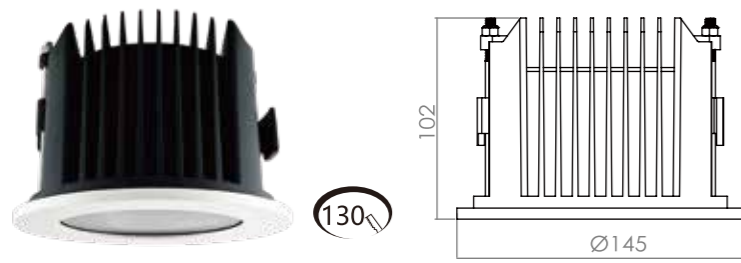
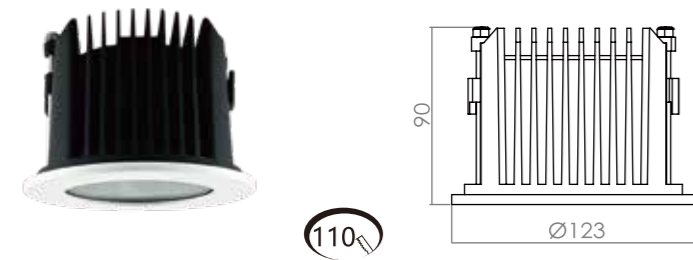

單位:mm

面框: ○ 白 ● 黑

遮光罩: ● 黑

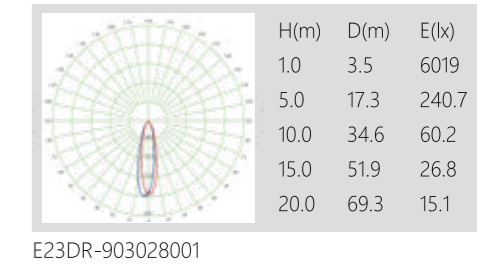
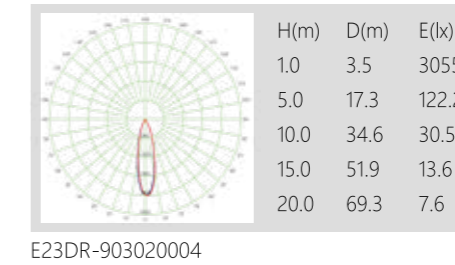
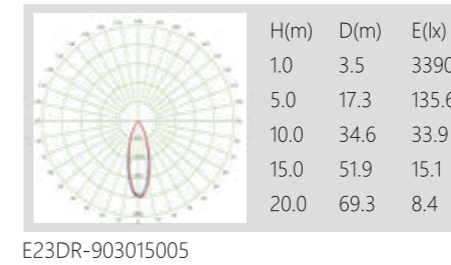

型號	功率 (W)	電壓 (V)	色溫 (K)	色容差	光通量	顯色指數 (Ra)	光束角	燈具尺寸 (mm)	挖孔尺寸 (mm)
E23DR-903015005	15W	100V-277V	3000K	3 SDCM	880lm	≥90	15°/24°/38°	H78×Φ92mm	Φ80mm
E23DR-903020004	20W	100V-277V	3000K	3 SDCM	1250lm	≥90	15°/24°/38°	H90×Φ123mm	Φ110mm
E23DR-903028001	28W	100V-277V	3000K	3 SDCM	1750lm	≥90	15°/24°/38°	H102×Φ145mm	Φ130mm

- IP65防水等級
- 低眩光
- 高演色性真實還原色彩

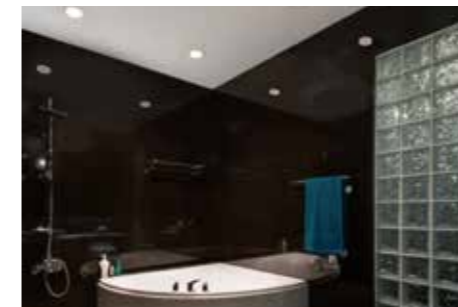

# Pyxis Series

## PYX-L 嵌入式下拉崁燈

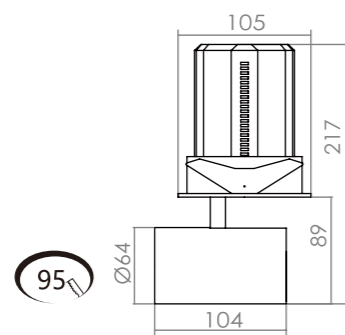
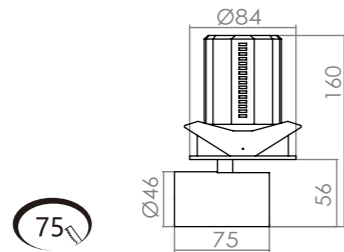
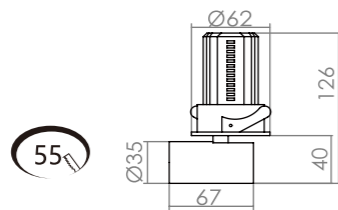

單位:mm

■ 可變發光方向

■ 低眩光

■ 高演色性真實還原色彩



面框: ○ 白 ● 黑

遮光罩: ● 黑

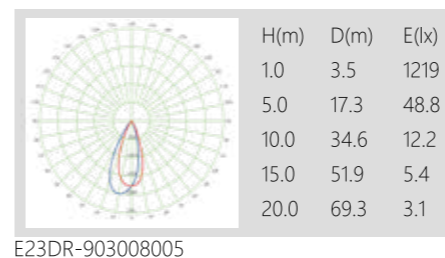

E23DR-903008005

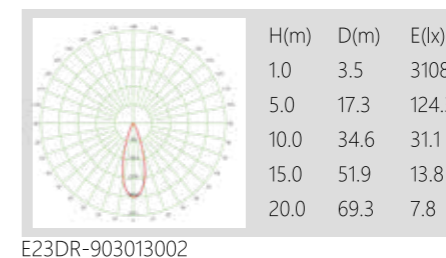

E23DR-903013002

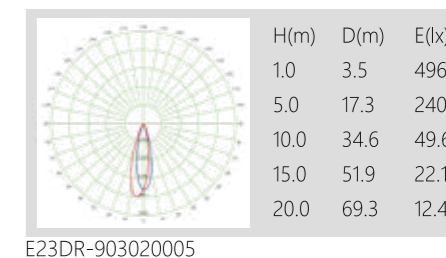

E23DR-903020005

型號	功率 (W)	電壓 (V)	色溫 (K)	色容差	光通量	顯色指數 (Ra)	光束角	燈具尺寸 (mm)	挖孔尺寸 (mm)
E23DR-903008005	8W	100V-277V	3000K	3 SDCM	630lm	≥90	15°/24°/36°	H80×Φ35mm	Φ55mm
E23DR-903013002	13W	100V-277V	3000K	3 SDCM	1110lm	≥90	15°/24°/36°	H80×Φ46mm	Φ75mm
E23DR-903020005	20W	100V-277V	3000K	3 SDCM	1870lm	≥90	15°/24°/36°	H101×Φ64mm	Φ95mm

# Pyxis Series

## PYX-M 嵌入式長條燈

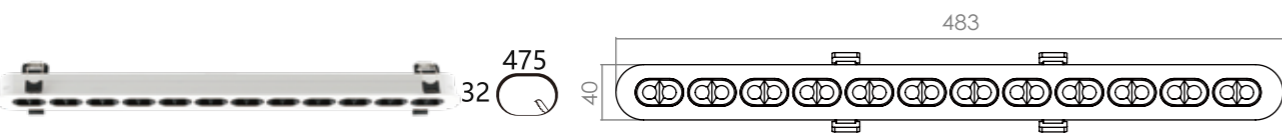
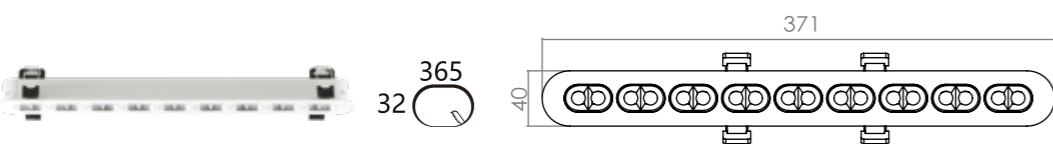
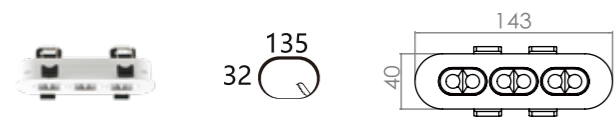

單位:mm

■ 線條簡約、易安裝

■ 低眩光

■ 高演色性真實還原色彩



面框: ○ 白 ● 黑

遮光罩: ● 黑 ● 銀

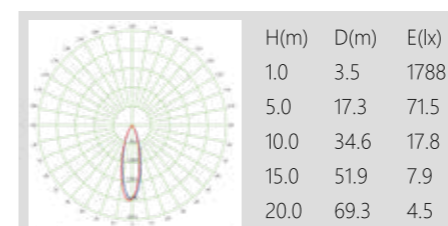

E23DL-903006001

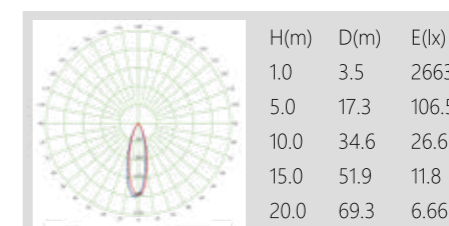

E23DL-903012001

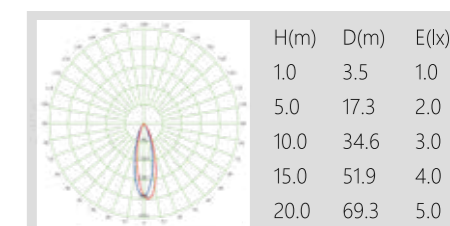

E23DL-903018001

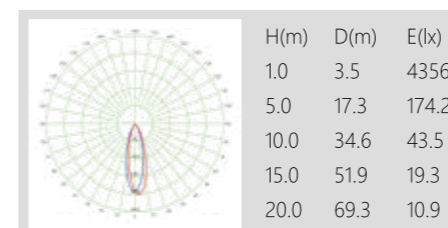

E23DL-903024001

型號	功率 (W)	電壓 (V)	色溫 (K)	色容差	光通量	顯色指數 (Ra)	光束角	燈具尺寸 (mm)	挖孔尺寸 (mm)
E23DL-903006001	6W	100V-277V	3000K	3 SDCM	580lm	≥90	24°/36°	H41X143×40mm	145X35mm
E23DL-903012001	12W	100V-277V	3000K	3 SDCM	910lm	≥90	24°/36°	H41×258×40mm	260X35mm
E23DL-903018001	18W	100V-277V	3000K	3 SDCM	1500lm	≥90	24°/36°	H41×371×40mm	375X35mm
E23DL-903024001	24W	100V-277V	3000K	3 SDCM	1800lm	≥90	24°/36°	H41×483×40mm	485X35mm



COCKTAIL & WHISKY **Edison** concept



PYX-N Series

# Pyxis Series

## PYX-N 嵌入式窄角嵌燈

面框: ○ 白 ● 黑



55°

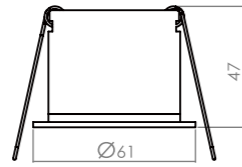

75°

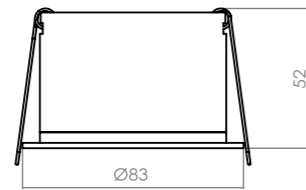

單位:mm

- 可變發光方向
- 低眩光
- 高演色性真實還原色彩

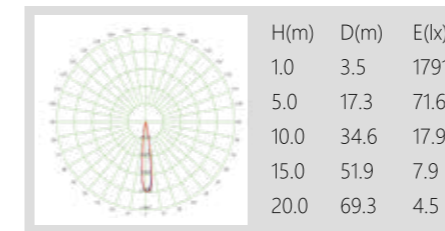

E23DR-903003001

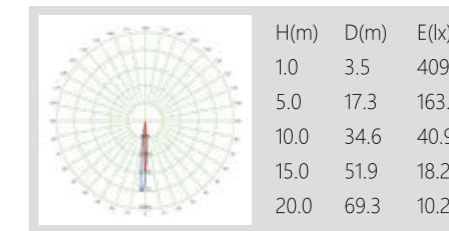

E23DR-903003002

型號	功率 (W)	電壓 (V)	色溫 (K)	色容差	光通量	顯色指數 (Ra)	光束角	燈具尺寸 (mm)	挖孔尺寸 (mm)
E23DR-903003001	3W	100V-277V	3000K	3 SDCM	145lm	≥90	10°	H47×Φ61mm	Φ55mm
E23DR-903003002	3W	100V-277V	3000K	3 SDCM	156lm	≥90	5°	H52×Φ83mm	Φ75mm





# Pyxis Series

## PYX-O 嵌入式嵌燈

燈身: ○ 白 ● 黑

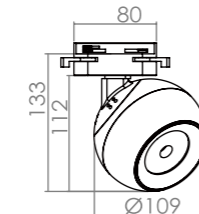
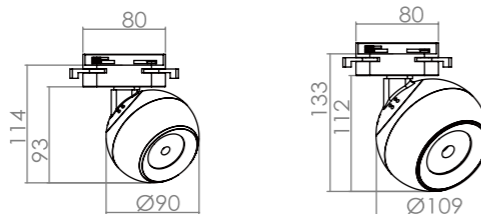
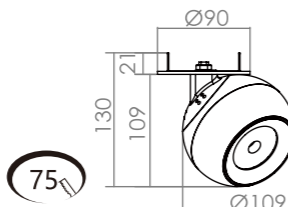
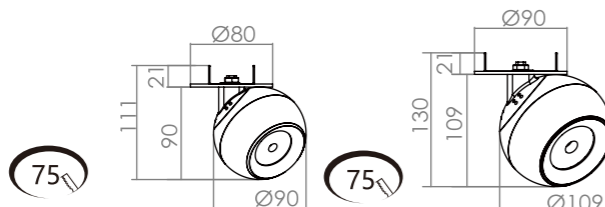
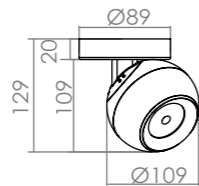
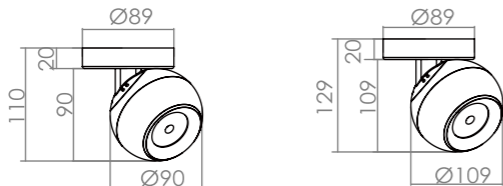

單位:mm

- 可變發光方向
- 低眩光
- 高演色性真實還原色彩

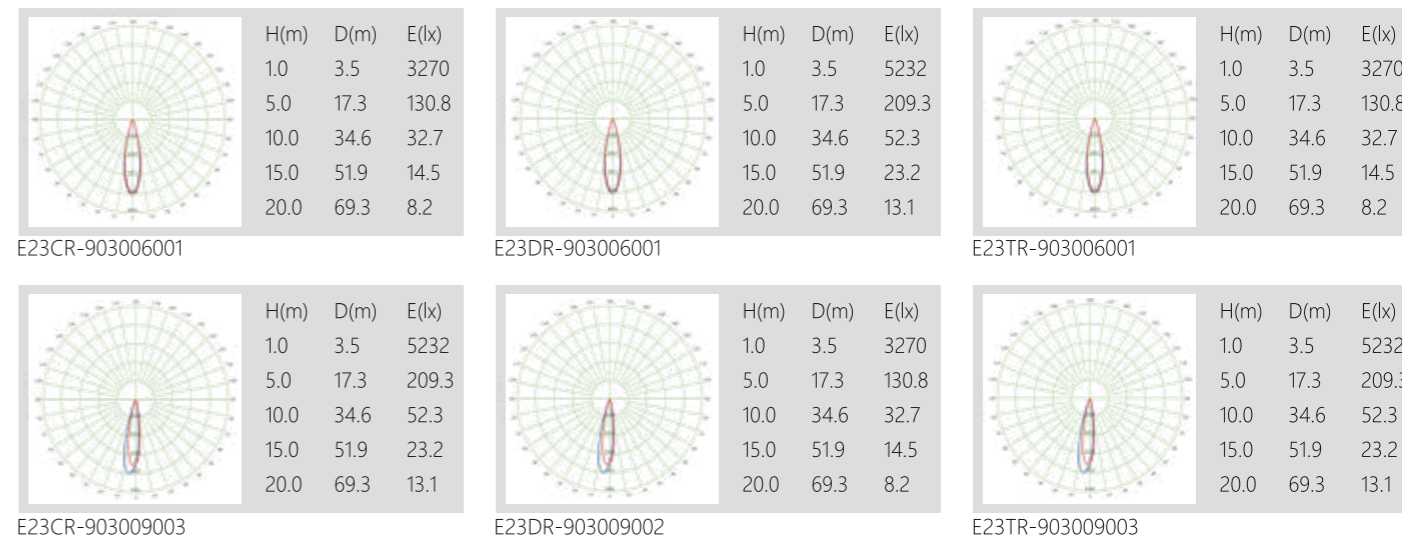

型號	功率 (W)	電壓 (V)	色溫 (K)	色容差	光通量	顯色指數 (Ra)	光束角	燈具尺寸 (mm)	挖孔尺寸 (mm)
E23CR-903006001	6W	100V-277V	3000K	3 SDCM	620lm	≥90	12°/24°/36°	H110×Φ90mm	
E23CR-903009003	9W	100V-277V	3000K	3 SDCM	815lm	≥90	12°/24°/36°	H129×Φ109mm	
E23DR-903006001	6W	100V-277V	3000K	3 SDCM	620lm	≥90	12°/24°/36°	H111×Φ90mm	Φ75mm
E23DR-903009002	9W	100V-277V	3000K	3 SDCM	815lm	≥90	12°/24°/36°	H130×Φ109mm	Φ75mm
E23TR-903006001	6W	100V-277V	3000K	3 SDCM	620lm	≥90	12°/24°/36°	H114×Φ90mm	
E23TR-903009003	9W	100V-277V	3000K	3 SDCM	815lm	≥90	25°	H133×Φ109mm	





# Pyxis Series

## PYX-P PLCC LITE II



90°

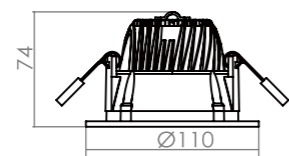

120°

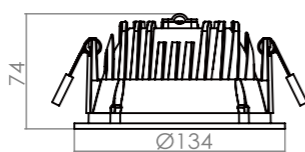

150°

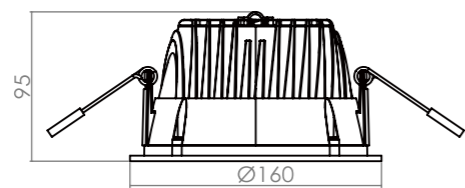

200°

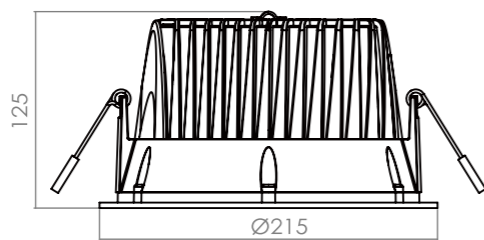

單位:mm

■ 多種規格可供選擇

■ 低眩光

■ 高演色性真實還原色彩



面框: ○ 白 ● 黑

遮光罩: ● 電鍍銀

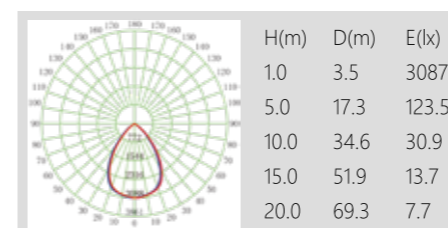
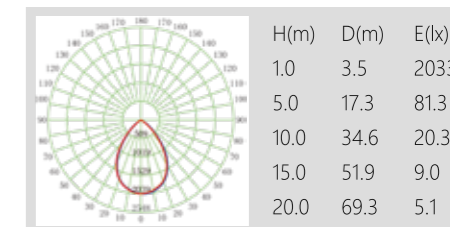
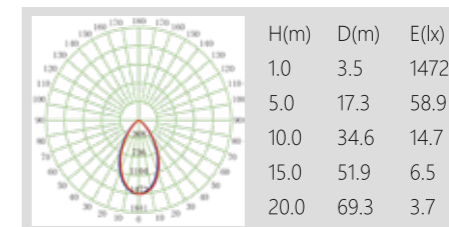
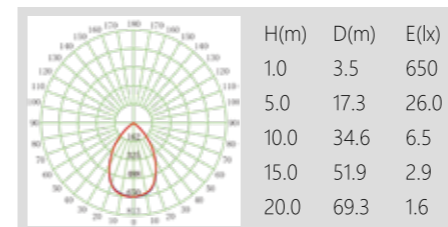

型號	功率 (W)	電壓 (V)	色溫 (K)	色容差	光通量	顯色指數 (Ra)	光束角	燈具尺寸 (mm)	挖孔尺寸 (mm)
EC7DR31D072930BR01	7W	100V-277V	3000K	3 SDCM	805lm	≥90	70°	H74×Φ110mm	Φ90mm
EC7DR31D072930BR02	7W	100V-277V	4000K	3 SDCM	805lm	≥90	25°	H74×Φ110mm	Φ90mm
EC7DR32D122930BR01	7W	100V-277V	5700K	3 SDCM	805lm	≥90	25°	H74×Φ110mm	Φ90mm
EC7DR32D122930BR02	12W	100V-277V	3000K	3 SDCM	1465lm	≥90	60°	H74×Φ134mm	Φ120mm
EC7DR33D202930BR01	12W	100V-277V	4000K	3 SDCM	1465lm	≥90	25°	H74×Φ134mm	Φ120mm
EC7DR33D202930BR02	12W	100V-277V	5700K	3 SDCM	1465lm	≥90	25°	H74×Φ134mm	Φ120mm
EC7DR34D262930BR01	22W	100V-277V	3000K	3 SDCM	2685lm	≥90	75°	H95×Φ160mm	Φ150mm
EC7DR34D262930BR02	22W	100V-277V	4000K	3 SDCM	2685lm	≥90	75°	H95×Φ160mm	Φ150mm
EC7DR33D202930BR01	22W	100V-277V	5700K	3 SDCM	2685lm	≥90	75°	H95×Φ160mm	Φ150mm
EC7DR33D202930BR02	34W	100V-277V	3000K	3 SDCM	4040lm	≥90	75°	H125×Φ215mm	Φ200mm
EC7DR34D262930BR01	34W	100V-277V	4000K	3 SDCM	4040lm	≥90	75°	H125×Φ215mm	Φ200mm
EC7DR34D262930BR02	34W	100V-277V	5700K	3 SDCM	4040lm	≥90	75°	H125×Φ215mm	Φ200mm

# Telescopium Series | TEL-A 方形軌道燈

燈身: ○ 白 ● 黑 ● 灰

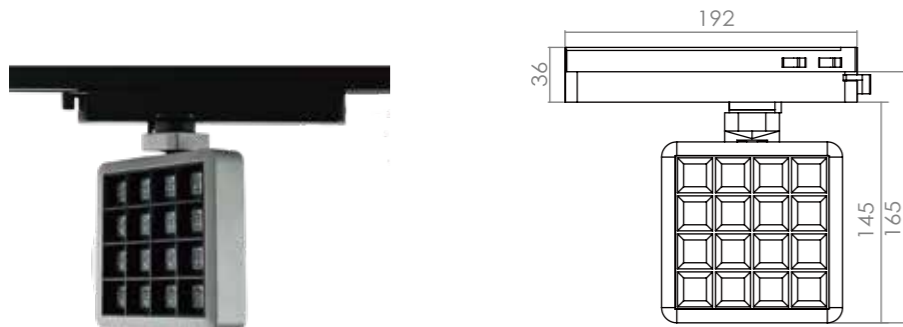
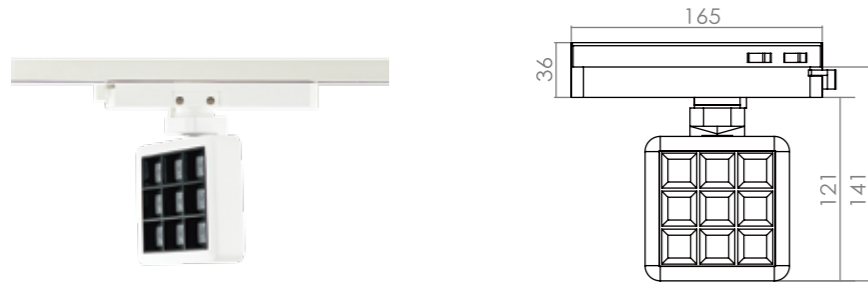

單位:mm

- 任意旋轉調整照射角度
- 可選擇二線或四線電軌道
- 低眩光、高演色性真實還原色彩

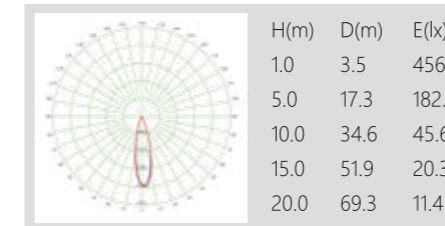

E23DR-903015005

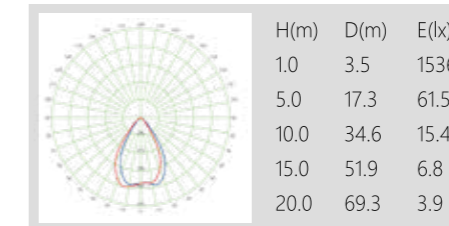

E23DR-903020004

型號	功率 (W)	電壓 (V)	色溫 (K)	色容差	光通量	顯色指數 (Ra)	光束角	燈具尺寸 (mm)	挖孔尺寸 (mm)
E23DR-903015005	15W	100V-277V	3000K	3 SDCM	1115lm	≥90	15°/24°/36°	H157×165mm	
E23DR-903020004	27W	100V-277V	3000K	3 SDCM	1755lm	≥90	15°/24°/36°	H177×192mm	



# Telescopium Series | TEL-B 軌道燈

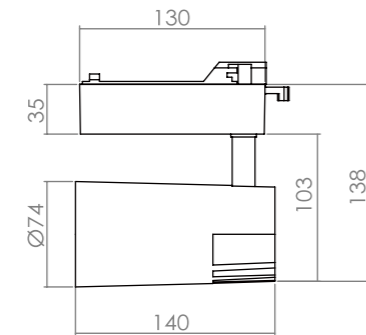
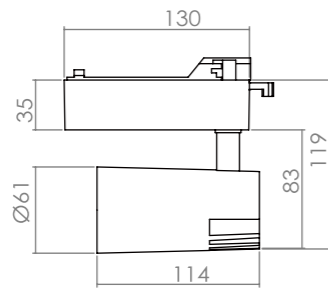
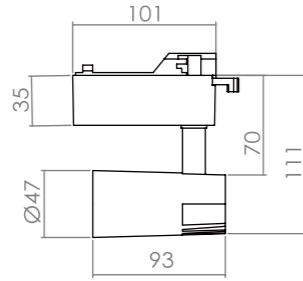

燈身: ○ 白 ● 黑 ● 灰

遮光罩: ○ 白

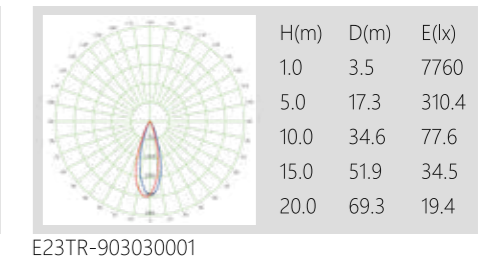
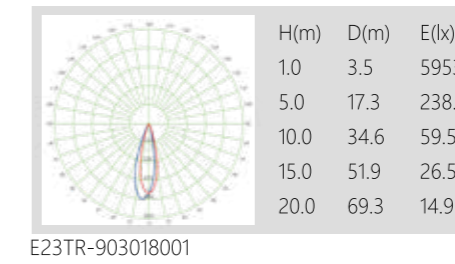
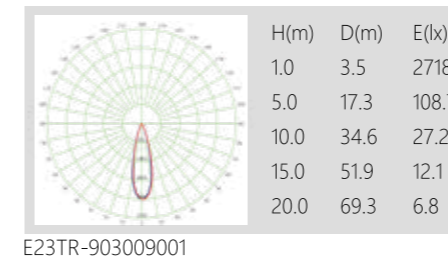

型號	功率 (W)	電壓 (V)	色溫 (K)	色容差	光通量	顯色指數 (Ra)	光束角	燈具尺寸 (mm)	挖孔尺寸 (mm)
E23TR-903009001	9W	100V-277V	3000K	3 SDCM	720lm	≥90	15°/24°/36°	H111×Φ47mm	
E23TR-903018001	18W	100V-277V	3000K	3 SDCM	1445lm	≥90	15°/24°/36°	H119×Φ61mm	
E23TR-903030001	30W	100V-277V	3000K	3 SDCM	2560lm	≥90	15°/24°/36°	H138×Φ74mm	

單位:mm

■ 任意調整照射角度

■ 可選擇二線或四線電軌道

■ 低眩光、高演色性真實還原色彩



# Telescopium Series | TEL-C 軌道燈

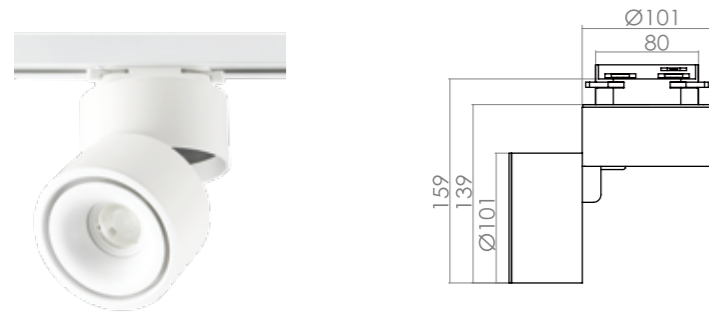
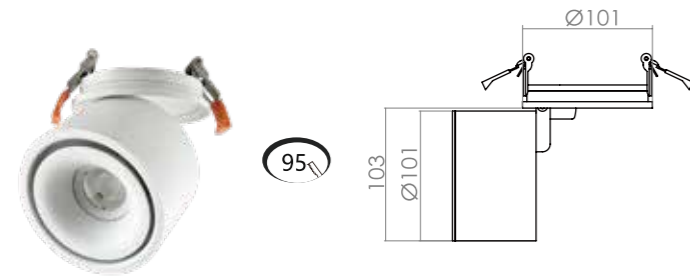

單位:mm

■ 任意調整照射角度

■ 可選擇二線或四線電軌道

■ 低眩光、高演色性真實還原色彩



燈身: ○ 白 ● 黑

遮光罩: ○ 白 ● 黑

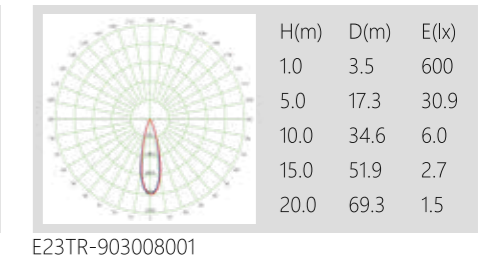
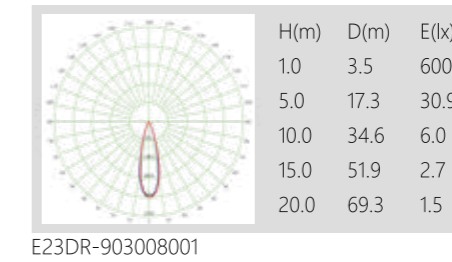
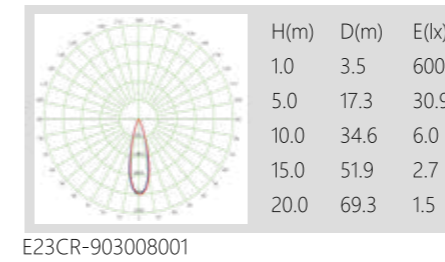

型號	功率 (W)	電壓 (V)	色溫 (K)	色容差	光通量	顯色指數 (Ra)	光束角	燈具尺寸 (mm)	挖孔尺寸 (mm)
E23CR-903008001	8W	100V-277V	3000K	3 SDCM	545lm	≥90	24°/36°	H139×Φ101mm	
E23DR-903008001	8W	100V-277V	3000K	3 SDCM	545lm	≥90	24°/36°	H103×Φ101mm	Φ95mm
E23TR-903008001	8W	100V-277V	3000K	3 SDCM	545lm	≥90	24°/36°	H159×Φ101mm	



# Telescopium Series | TEL-E 軌道燈

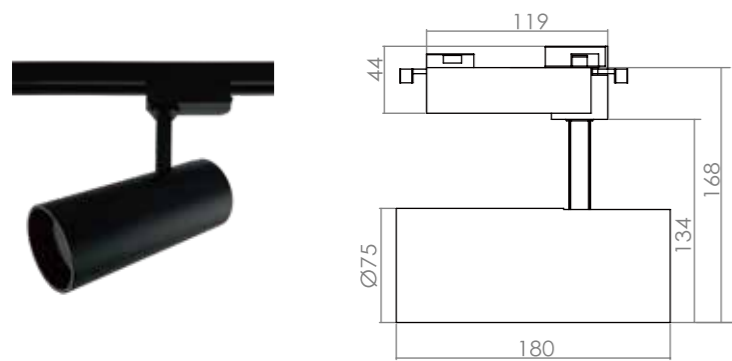
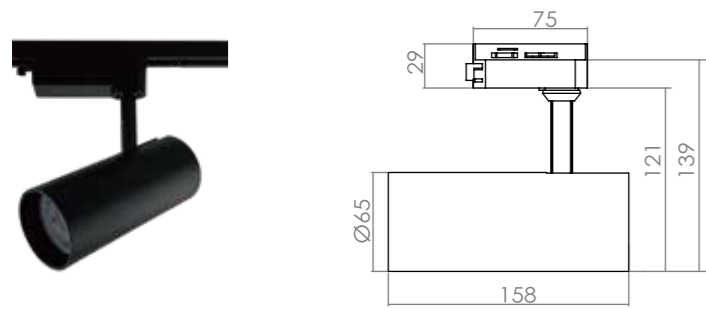
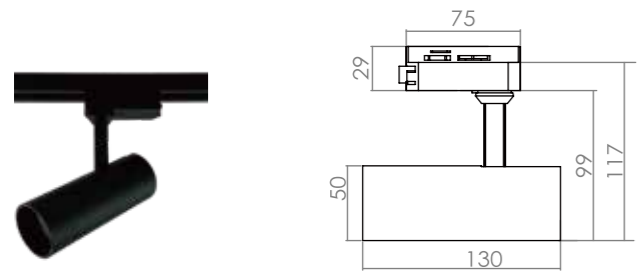

單位:mm

■ 可變發光方向

■ 可選擇二線或四線電軌道

■ 低眩光、高演色性真實還原色彩



燈身: ○ 白 ● 黑

遮光罩: ○ 白 ● 黑

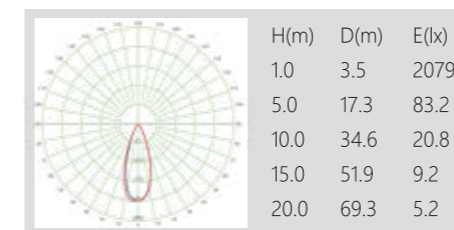

E23TR-903012001

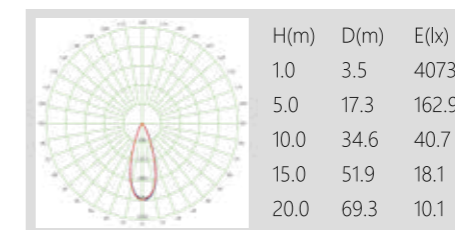

E23TR-903020001

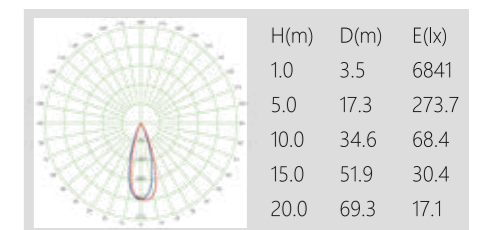

E23TR-903030002

型號	功率 (W)	電壓 (V)	色溫 (K)	色容差	光通量	顯色指數 (Ra)	光束角	燈具尺寸 (mm)	挖孔尺寸 (mm)
E23TR-903012001	12W	100V-277V	3000K	3 SDCM	900lm	≥90	15°/24°/36°	H117×Φ50mm	
E23TR-903020001	20W	100V-277V	3000K	3 SDCM	1605lm	≥90	15°/24°/36°	H139×Φ65mm	
E23TR-903030002	30W	100V-277V	3000K	3 SDCM	2290lm	≥90	15°/24°/36°	H168×Φ75mm	







Edison

HOP-A Series

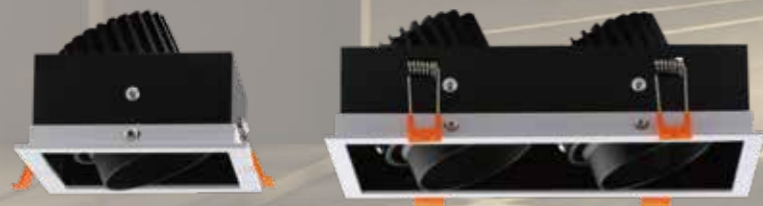



# Horologium Series | HOP-A 盒燈

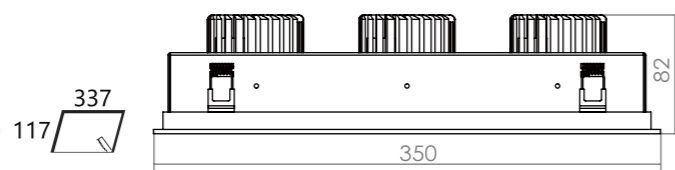
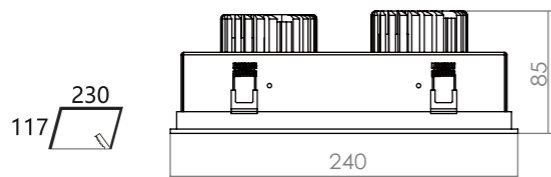
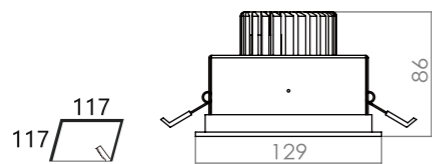

單位:mm

- 多方位角度調節
- 低眩光
- 高演色性真實還原色彩



面框: ○ 白 ● 黑

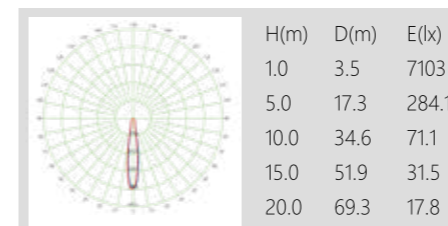

E23BS-903015001

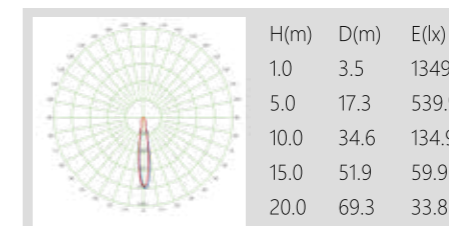

E23BL-903030001

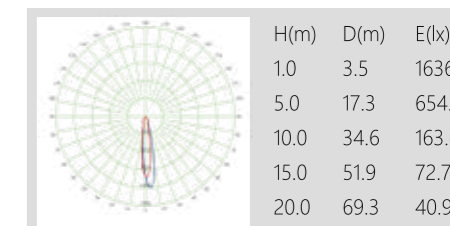

E23BL-903045001

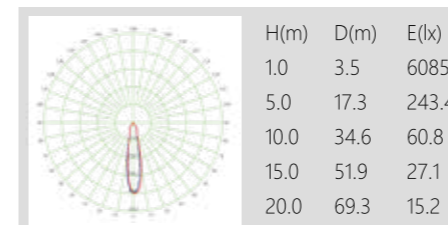

E23BL-903045001

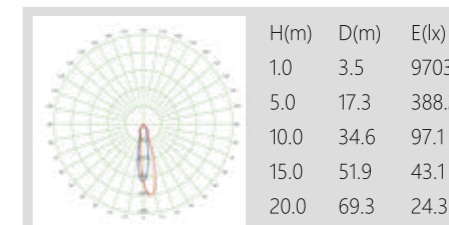

E23BS-903020001

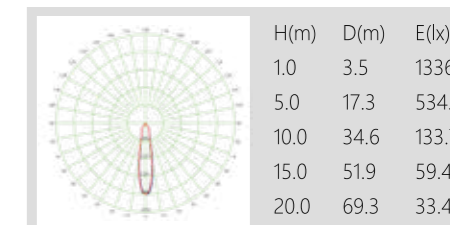

E23BL-903040001

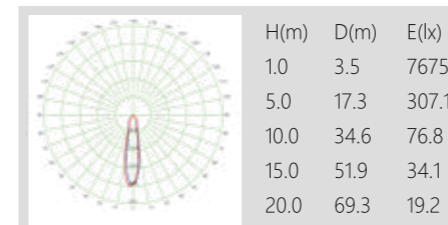

E23BS-903030001

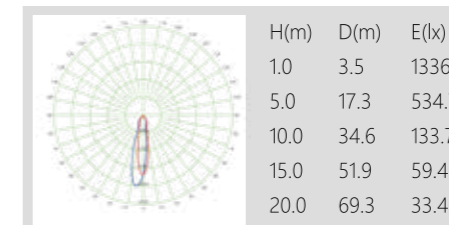

E23BL-903060002

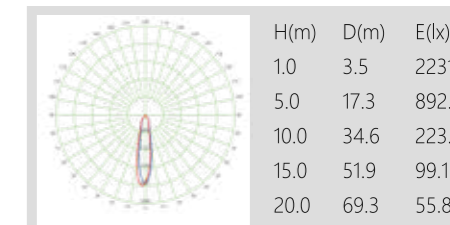

E23BL-903090001

型號	功率 (W)	電壓 (V)	色溫 (K)	色容差	光通量	顯色指數 (Ra)	光束角	燈具尺寸 (mm)	挖孔尺寸 (mm)
E23BS-903015001	15W	100V-277V	3000K	3 SDCM	1020lm	≥90	15°/24°/36°	H86×129×129mm	117x117mm
E23BL-903030001	30W	100V-277V	3000K	3 SDCM	2040lm	≥90	15°/24°/36°	H85×124x240mm	117x230mm
E23BL-903045001	45W	100V-277V	3000K	3 SDCM	3115lm	≥90	15°/24°/36°	H82×128x350mm	117x337mm
E23BS-903020001	20W	100V-277V	3000K	3 SDCM	1390lm	≥90	15°/24°/36°	H86×129x129mm	117x117mm
E23BL-903040001	40W	100V-277V	3000K	3 SDCM	2800lm	≥90	15°/24°/36°	H85×124x240mm	117x230mm
E23BL-903060001	60W	100V-277V	3000K	3 SDCM	3760lm	≥90	15°/24°/36°	H82×128x350mm	117x337mm
E23BS-903030001	30W	100V-277V	3000K	3 SDCM	1835lm	≥90	15°/24°/36°	H86x129×129mm	117x117mm
E23BL-903060002	60W	100V-277V	3000K	3 SDCM	3765lm	≥90	15°/24°/36°	H86×124X240mm	117x230mm
E23BL-903090001	90W	100V-277V	3000K	3 SDCM	5525lm	≥90	15°/24°/36°	H85×128x350mm	117x337mm

# Horologium Series | HOP-B 盒燈

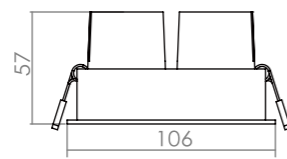
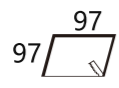
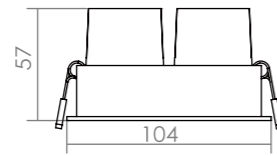
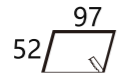
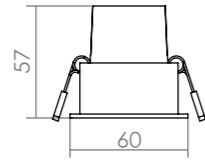
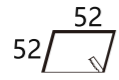

單位:mm

■ 易安裝

■ 低眩光

■ 高演色性真實還原色彩



面框: ○ 白 ● 黑

遮光罩: ● 黑

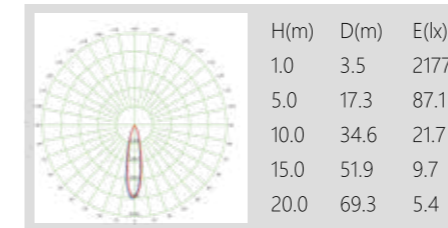

E23BS-903007001

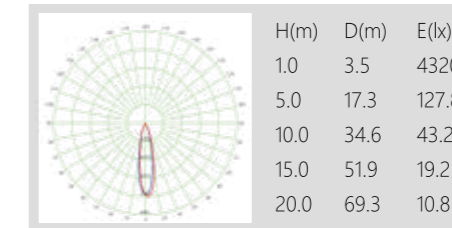

E23BL-903014001

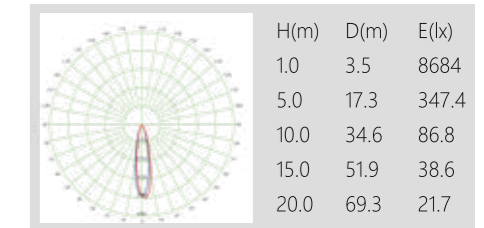

E23BS-903028001

型號	功率 (W)	電壓 (V)	色溫 (K)	色容差	光通量	顯色指數 (Ra)	光束角	燈具尺寸 (mm)	挖孔尺寸 (mm)
E23BS-903007001	7W	100V-277V	3000K	3 SDCM	410lm	≥90	15°/24°/36°	H57×60x60mm	52x52mm
E23BL-903014001	14W	100V-277V	3000K	3 SDCM	835lm	≥90	15°/24°/36°	H57×104x60mm	52x97mm
E23BS-903028001	28W	100V-277V	3000K	3 SDCM	1630lm	≥90	15°/24°/36°	H57×106x106mm	97x97mm



# Vela Series | VEL-A 櫥櫃燈

燈身:  銀

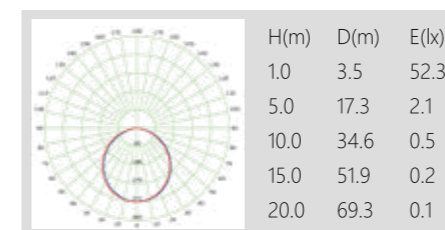
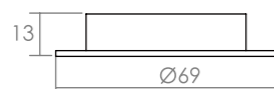

E23DR-800203001

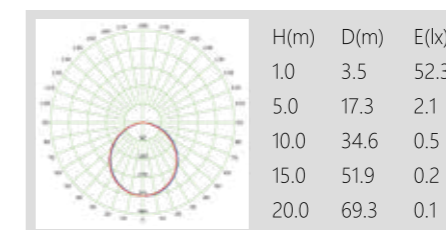

E23DR-800203001

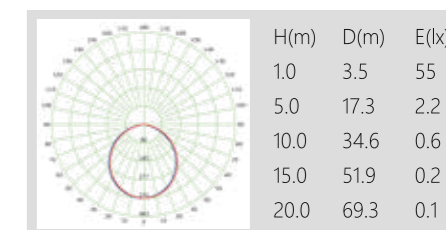

E23DR-804003001

型號	功率 (W)	電壓 (V)	色溫 (K)	色容差	光通量	顯色指數 (Ra)	光束角	燈具尺寸 (mm)	挖孔尺寸 (mm)
E23DR-800203001	3W	100V-277V	2700K-4000K	3 SDCM	140lm	≥80	110°	H13×Φ69mm	
E23DR-804003001	3W	100V-277V	4000K	3 SDCM	150lm	≥80	110°	H13×Φ69mm	

單位:mm

■ 薄型廚櫃燈

■ 低眩光

■ 可調色溫







VEL-B Series

# Vela Series

## VEL-B IP44吸頂筒燈

燈身: ○ 白 ● 黑

遮光罩: ○ 白 ● 黑

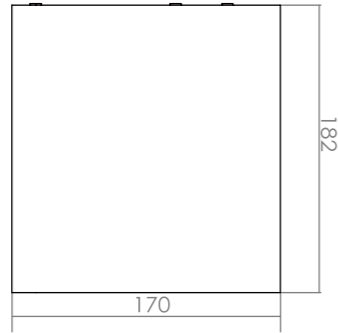
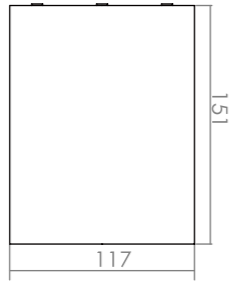
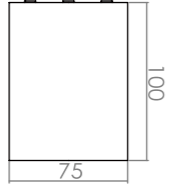

單位:mm

■ IP44防塵防水

■ 內縮設計防眩光

■ 高演色性真實還原色彩

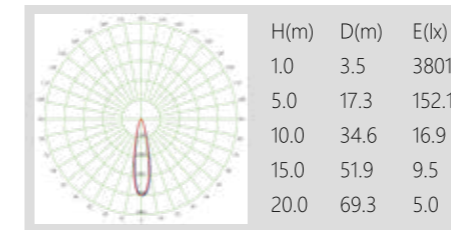

E23CR-903010001

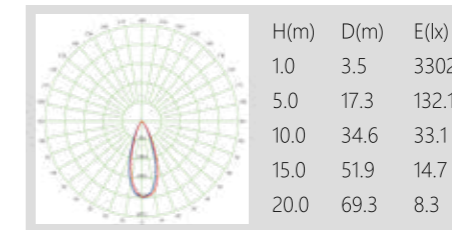

E23CR-903018001

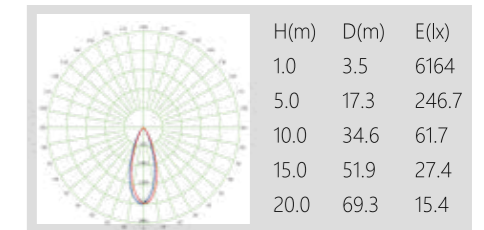

E23CR-903036001

型號	功率 (W)	電壓 (V)	色溫 (K)	色容差	光通量	顯色指數 (Ra)	光束角	燈具尺寸 (mm)	挖孔尺寸 (mm)
E23CR-903010001	10W	100V-277V	3000K	3 SDCM	800lm	≥90	20°/40°	H100×Φ75mm	
E23CR-903018001	18W	100V-277V	3000K	3 SDCM	1565lm	≥90	20°/40°	H151×Φ117mm	
E23CR-903036001	36W	100V-277V	3000K	3 SDCM	2930lm	≥90	20°/40°	H182×Φ170mm	



# Vela Series | VEL-C 吸頂燈

燈身: ○ 白 ● 黑 ● 玫瑰金 ● 槍黑 ● 電鍍銀

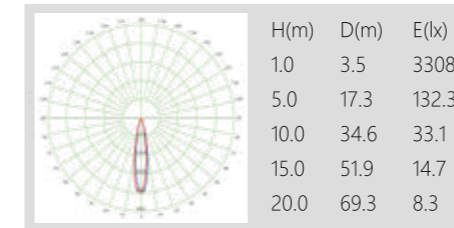
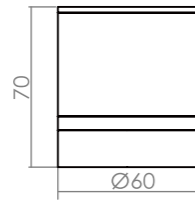

E23CR-903007003

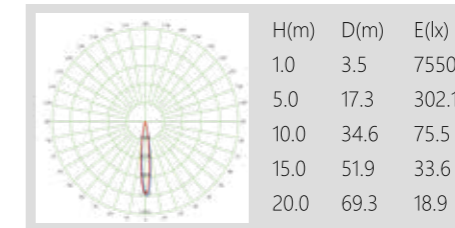

E23CR-903009002

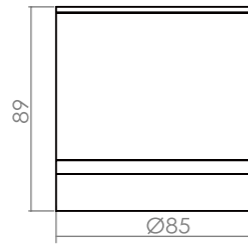

型號	功率 (W)	電壓 (V)	色溫 (K)	色容差	光通量	顯色指數 (Ra)	光束角	燈具尺寸 (mm)	挖孔尺寸 (mm)
E23CR-903007003	7W	100V-277V	3000K	3 SDCM	500lm	≥90	24°	H70×Φ60mm	
E23CR-903009002	9W	100V-277V	3000K	3 SDCM	630lm	≥90	24°	H89×Φ85mm	

單位:mm

- 乾淨俐落
- 低眩光
- 高演色性真實還原色彩





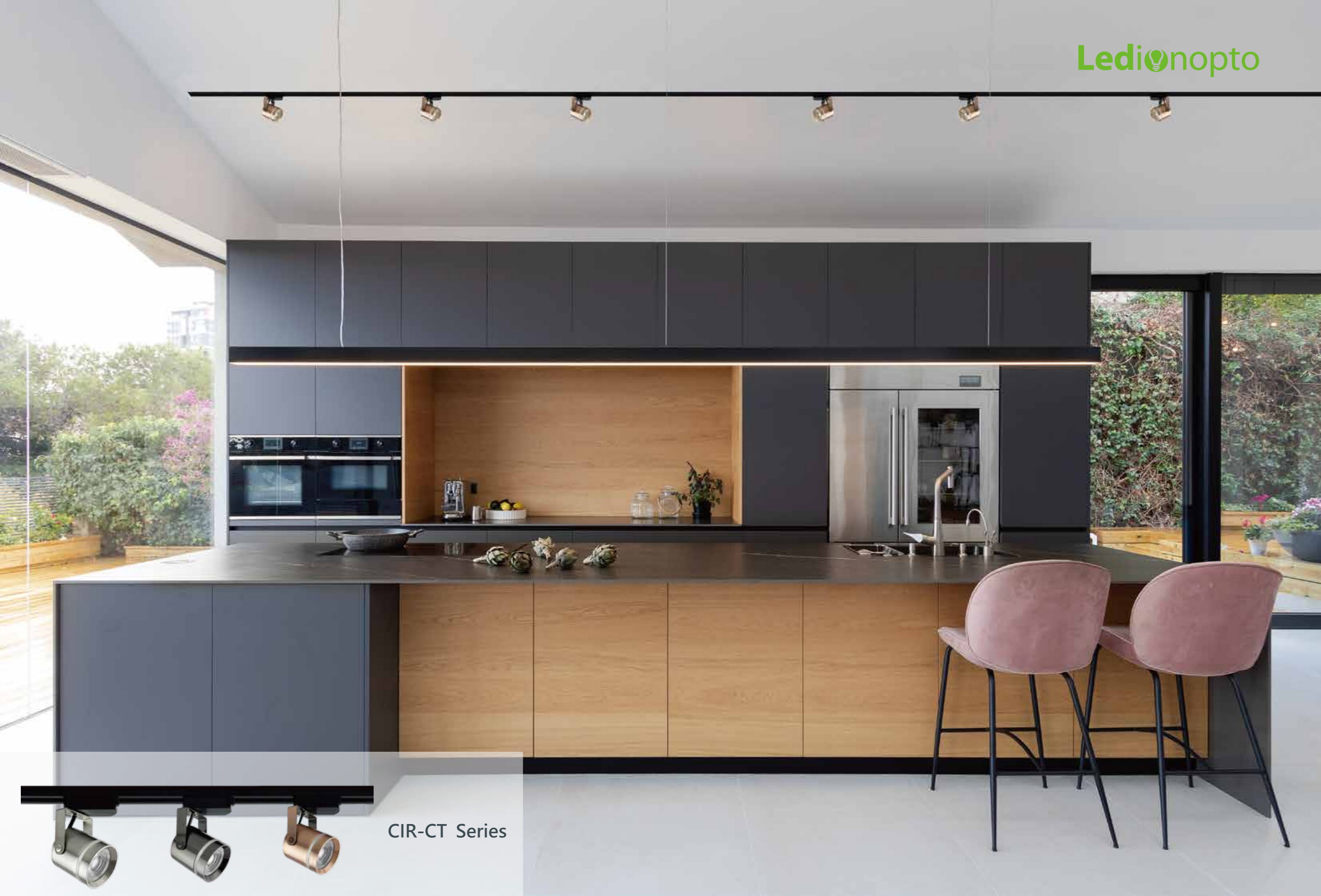

CIR-CT Series

# Vela Series

## VEL-CT 軌道燈

燈身: ○ 白 ● 黑 ● 玫瑰金 ● 槍黑 ● 電鍍銀

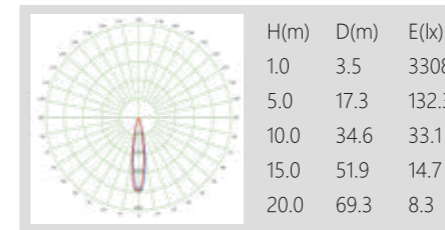
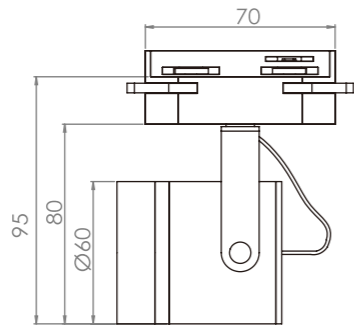

型號	功率 (W)	電壓 (V)	色溫 (K)	色容差	光通量	顯色指數 (Ra)	光束角	燈具尺寸 (mm)	挖孔尺寸 (mm)
E23TR-903007002	7W	100V-277V	3000K	3 SDCM	500lm	≥90	24°	H95×Φ60mm	

單位:mm

- 可變發光方向
- 可選擇二線或四線電軌道
- 低眩光、高演色性真實還原色彩



# Vela Series

## VEL-D 吸頂燈

面框: ○ 白 ● 黑

遮光罩: ● 金

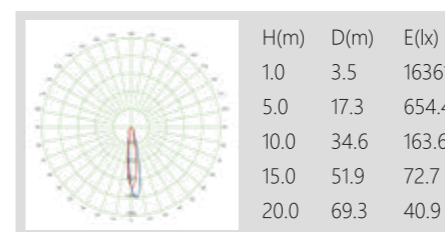
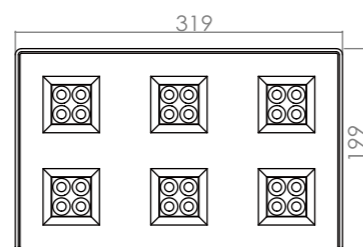
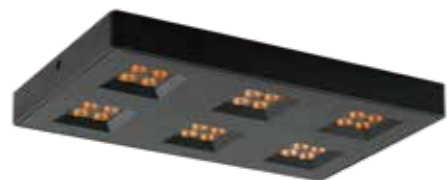

型號	功率 (W)	電壓 (V)	色溫 (K)	色容差	光通量	顯色指數 (Ra)	光束角	燈具尺寸 (mm)	挖孔尺寸 (mm)
E23CL-903045001	45W	220V-240V	3000K	3 SDCM	2210lm	≥90	24°/40°	H30×319x199mm	

單位:mm

■ 薄型設計優雅大方

■ 低眩光

■ 高演色性真實還原色彩





# Circinus Series | CIR-A 吊燈

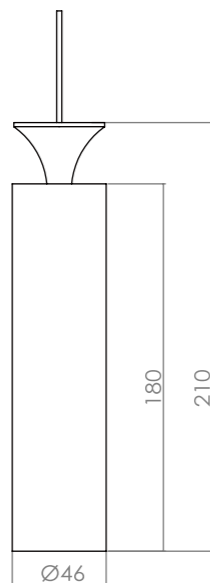

面框: ● 黑

遮光罩: ● 金

可選配件:

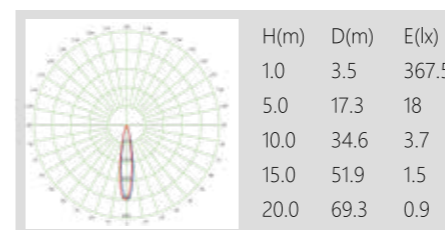
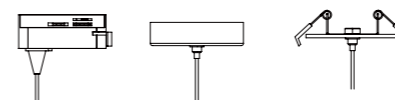

型號	功率 (W)	電壓 (V)	色溫 (K)	色容差	光通量	顯色指數 (Ra)	光束角	燈具尺寸 (mm)	挖孔尺寸 (mm)
E23AR-903007001	7W	100V-277V	3000K	3 SDCM	375lm	≥90	24°/36°	H210×Φ46mm	
E23DR-903007007	7W	100V-277V	3000K	3 SDCM	375lm	≥90	24°/36°	H210×Φ46mm	Φ50mm
E23TR-903007003	7W	100V-277V	3000K	3 SDCM	375lm	≥90	24°/36°	H210×Φ46mm	

單位:mm

■ 上下發光

■ 低眩光

■ 高演色性真實還原色彩



# Circinus Series | CIR-B 吊燈

燈身: ○ 白 ● 黑

遮光罩: ● 電鍍銀

可選配件:

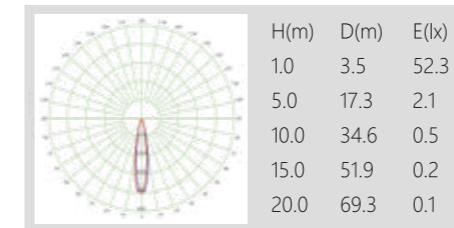
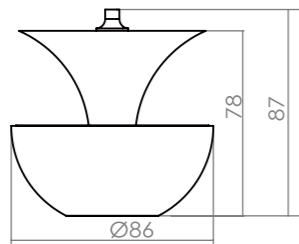
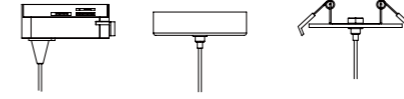

型號	功率 (W)	電壓 (V)	色溫 (K)	色容差	光通量	顯色指數 (Ra)	光束角	燈具尺寸 (mm)	挖孔尺寸 (mm)
E23AR-903003001	3W	100V-277V	3000K	3 SDCM	1275lm	≥90	24°	H87×Φ85mm	
E23DR-903003003	3W	100V-277V	3000K	3 SDCM	1700lm	≥90	24°	H87×Φ85mm	Φ50mm
E23TR-903003001	3W	100V-277V	3000K	3 SDCM	2380lm	≥90	24°	H87×Φ85mm	

單位:mm

■ 造型簡約設計

■ 低眩光

■ 高演色性真實還原色彩





Coffee Garden



CIR-CT Series



# Circinus Series | CIR-C 調焦吊燈

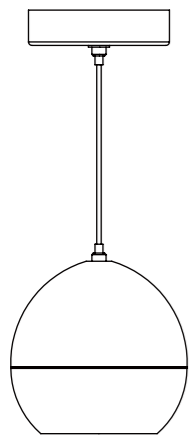
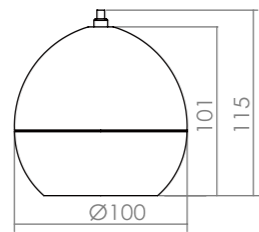

E23AR-903012001

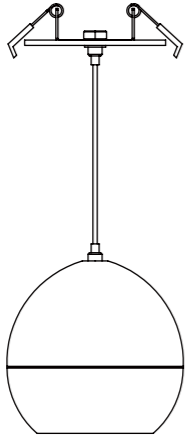

E23DR-903012003

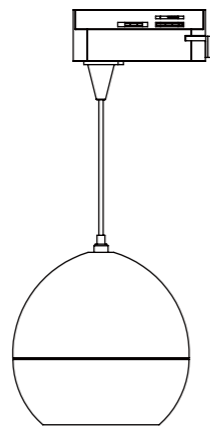

E23TR-903012002

單位:mm

■ 可調焦精準打光

■ 可搭配二線或四線軌道

■ 低眩光、高演色性真實還原色彩



燈身: ○ 白 ● 黑

遮光罩: ● 黑

可選配件:

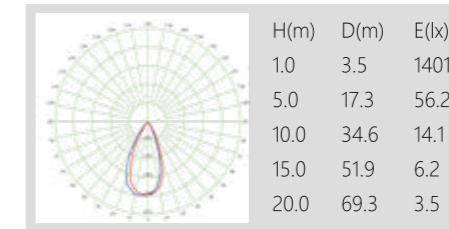
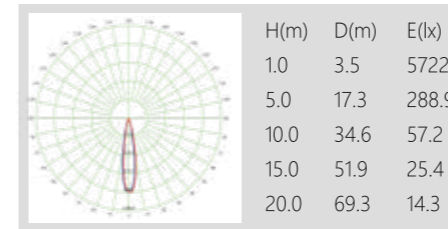

型號	功率 (W)	電壓 (V)	色溫 (K)	色容差	光通量	顯色指數 (Ra)	光束角	燈具尺寸 (mm)	挖孔尺寸 (mm)
E23AR-903012001	12W	100V-277V	3000K	3 SDCM	680lm/820lm	≥90	10°-55°	H115×Φ100mm	
E23DR-903012003	12W	100V-277V	3000K	3 SDCM	680lm/820lm	≥90	10°-55°	H115×Φ100mm	Φ50mm
E23TR-903012002	12W	100V-277V	3000K	3 SDCM	680lm/820lm	≥90	10°-55°	H115×Φ100mm	



# Circinus Series | CIR-CT 調焦軌道燈



燈身: ○ 白 ● 黑

遮光罩: ● 黑

可選配件:

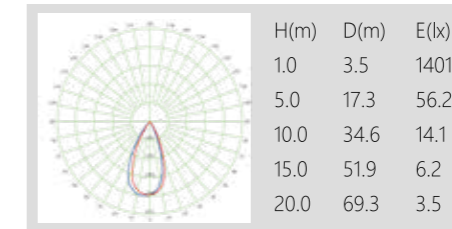
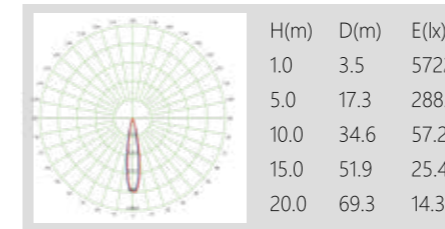

型號	功率 (W)	電壓 (V)	色溫 (K)	色容差	光通量	顯色指數 (Ra)	光束角	燈具尺寸 (mm)	挖孔尺寸 (mm)
E23TR-903012004	15W	100V-277V	3000K	3 SDCM	1275lm	≥90	10°-55°	H99×Φ100mm	

單位:mm

■ 可變發光方向

■ 可搭配二線或四線軌道

■ 低眩光、高演色性真實還原色彩



# Accessories Series | ACC 軌道

軌道顏色: ○ 白 ● 黑

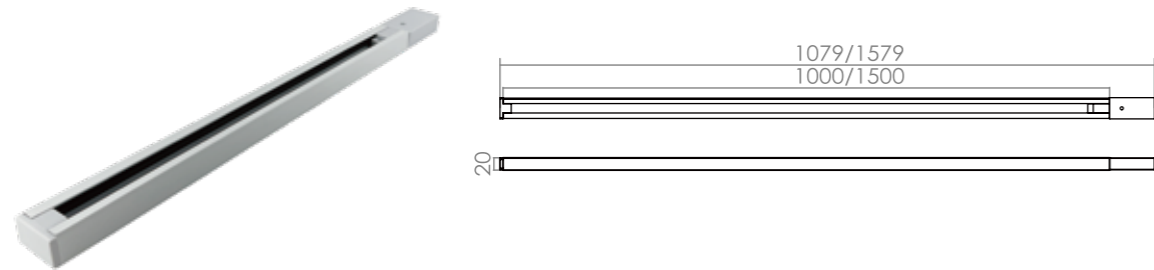
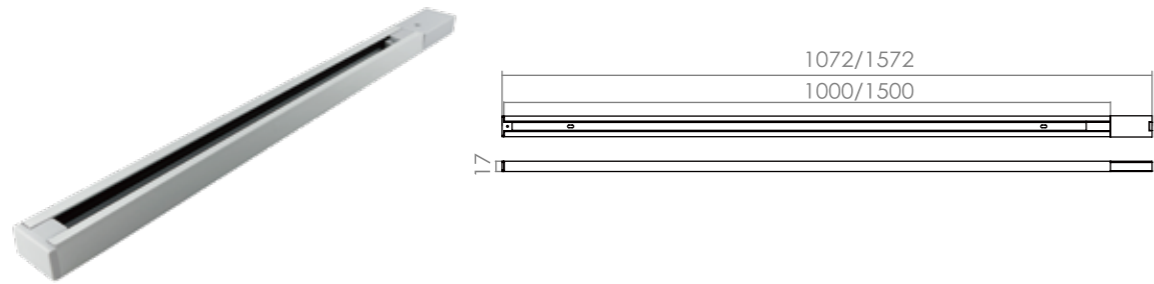
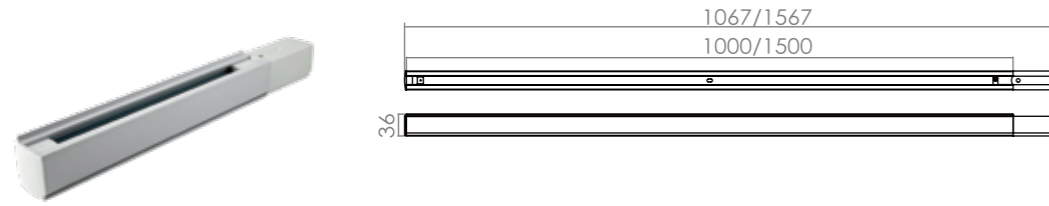

單位:mm

型號	規格	長度 (mm)
E23OT-020210001	二線軌道	1000
E23OT-020215001	二線軌道	1500
E23OT-020220001	二線軌道	2000
E23OT-030210001	三線軌道	1000
E23OT-030215001	三線軌道	1500
E23OT-030220001	三線軌道	2000
E23OT-040210001	四線軌道	1000
E23OT-040215001	四線軌道	1500
E23OT-040220001	四線軌道	2000







# Ledinopto

**Taipei Headquarter**

17F.,No.17, Qiaohe Rd., Zhonghe Dist.,New Taipei  
City 235029, Taiwan

**Dongguan Factory**

B16,No.9 Xinu Rd.,Xi-cheng Industrial Park,Heng-li,  
DongGuan City, Guandong Province, 523460,China

T:+86-769-8101-1898 F:+86-769-8101-1899